

[BookCover]

Class for book covers and dust jackets

bookcover.cls

v2.3 (2018/01/21)

Tibor Tómacs

tomacs.tibor@uni-eszterhazy.hu

1 Introduction

In the following picture we can see a typical dust jacket. Its parts are back flap, back, spine, front and front flap. Typographically, a book cover is a dust jacket without flaps, the only difference is that the book cover is a fixed part of the book, whereas the dust jacket is removable.

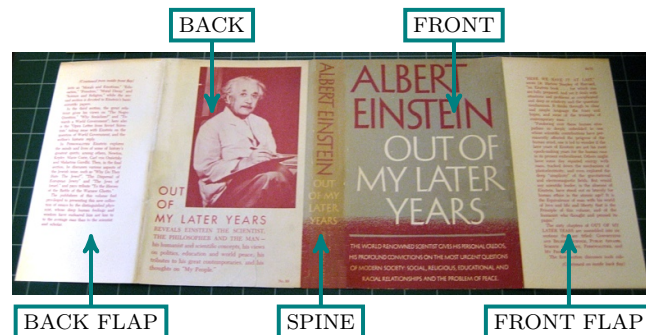

When we prepare a cover for printing, some marks are needed to know where to trim or fold the paper. These marks determine a special area of the sheet, which is called “bleed” (see the green area in the next figure). The background will be expanded onto the bleed, taking account of slight inaccuracy when trimming.

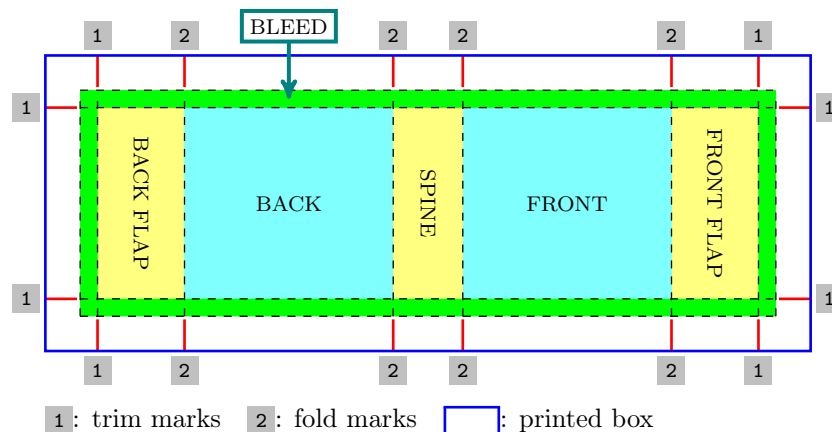

We get the following result after trimming:

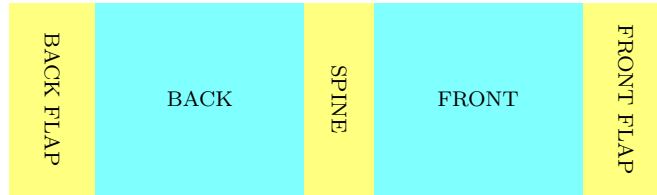

2 Loading class

The class `bookcover` requires the services of the class `article` and the following packages: `kvoptions`, `textpos`, `geometry`, `graphicx`, `calc`, `ifthen`, `tikz`, `fguler`.

Load the class as usual, with

```
\documentclass[options]{bookcover}
```

option	description	default value
<code>coverwidth=<length></code>	See the next figure	170mm
<code>coverheight=<length></code>		240mm
<code>spinewidth=<length></code>		5mm
<code>flapwidth=<length></code>		0mm
<code>marklength=<length></code>		10mm
<code>bleedwidth=<length></code>		5mm
<code>markthick=<length></code>	Thickness of marks	0.4pt
<code>markcolor=<color></code>	Color of marks	red
10pt	Normal font size (default: 10pt)	
11pt		
12pt		
<code>trimmed</code>	It shows trimmed version	false

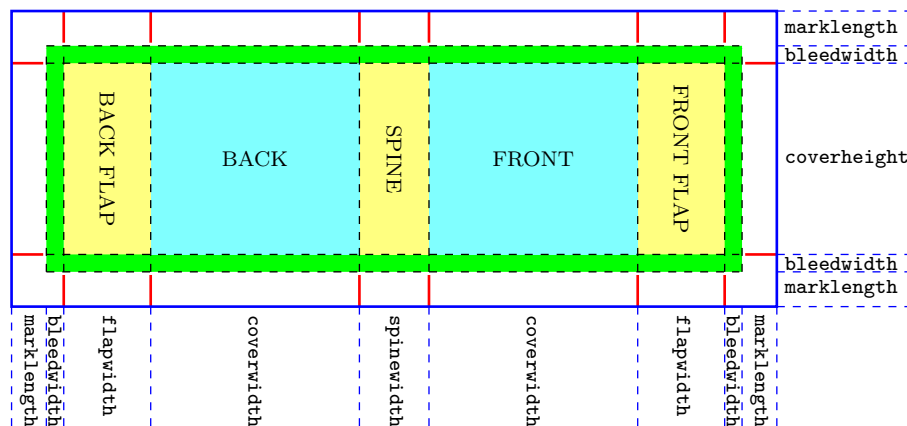

EXAMPLE

```
\documentclass[flapwidth=50mm,spinewidth=15mm]{bookcover}
```

3 Creating book cover

3.1 Commands

Use `bookcover` environment to make a new book cover. In this environment, you can create a component of the book cover by the following command:

```
\bookcovercomponent{component type}{part}{content}
```

<component type> See Subsection 3.3.

<part> See Subsection 3.2 or Section 4.

<content> It depends on the *<component type>*. See Subsection 3.3.

Every `\bookcovercomponent` generates a layer on the sheet. The first one generates the bottom layer and the last one generates the top layer.

EXAMPLE

```
\begin{bookcover}
  \bookcovercomponent{color}{bg whole}{color=blue}
  \bookcovercomponent{normal}{front}{
    \vspace{5cm}
    \begin{center}
      \bfseries\huge Book title
    \end{center}
  }
\end{bookcover}
```

3.2 Parts

Important: The background parts are expanded onto the bleed, taking account of slight inaccuracy when trimming!

3.2.1 One-piece background parts

`bg back flap`, `bg back`, `bg spine`, `bg front`, `bg front flap`

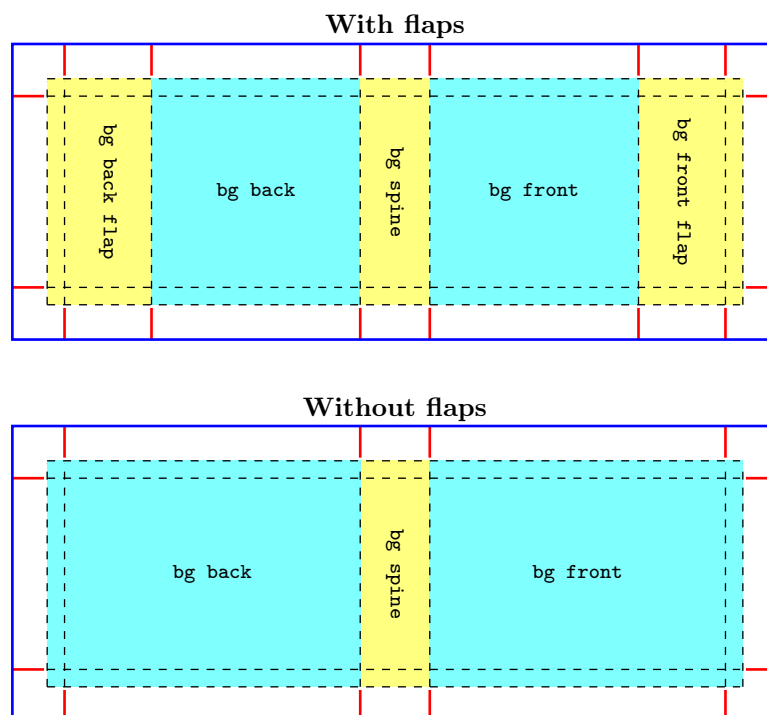

3.2.2 One-piece foreground parts

`back flap`, `back`, `spine`, `front`, `front flap`, `above back`, `above front`, `below back`, `below front`

With flaps

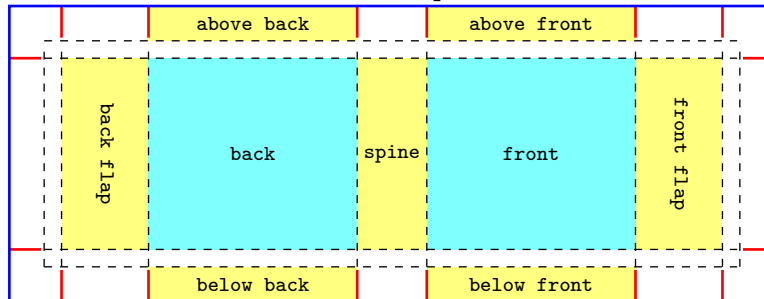

Without flaps

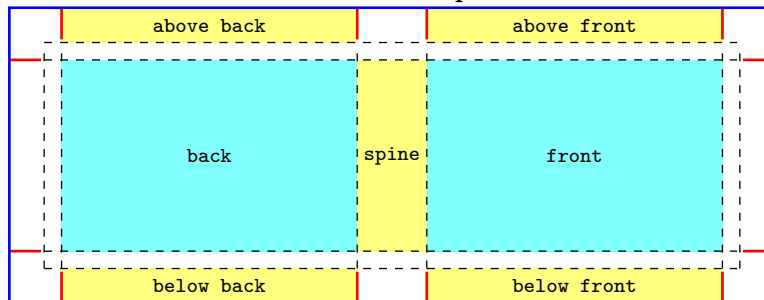

3.2.3 Combined parts

The following combined parts are defined. You can see illustrations in the Section 4.

background	foreground
bg back and flap	back and flap
bg back and spine	back and spine
bg front and spine	front and spine
bg front and flap	front and flap
bg back and flap and spine	back and flap and spine
bg front and flap and spine	front and flap and spine
bg whole without front flap	whole without front flap
bg whole without back flap	whole without back flap
bg whole without flaps	whole without flaps
bg whole	whole
whole page	

3.3 Component types

The following component types are defined: `color`, `picture`, `tikz`, `tikz clip`, `normal`, `center`, `ruler`.

3.3.1 Component type: color

`\bookcovercomponent{color}{<part>}{<colors>}`

It determines the color of the part.

<colors> The options of the `\fill` in the `tikz` package:

`color=<color name>` See *<color name>* in the `xcolor` package.

`top color=<color name>`

`bottom color=<color name>`

`middle color=<color name>`

`inner color=<color name>`

`outer color=<color name>`

`ball color=<color name>`

`shading angle=<degree>` It rotates the shading by the given angle.

EXAMPLE

```
\begin{bookcover}
  \bookcovercomponent{color}{bg whole without flaps}{
    top color=white, bottom color=blue!50!black, shading angle=60}
\end{bookcover}
```

3.3.2 Component type: picture

```
\bookcovercomponent{picture}{\langle part \rangle}{\langle picture file \rangle}
```

The picture will be rescaled according to the sizes of the *\langle part \rangle*.

EXAMPLE

```
\begin{bookcover}
  \bookcovercomponent{picture}{bg front flap}{fig.png}
\end{bookcover}
```

3.3.3 Component type: tikz

```
\bookcovercomponent{tikz}{\langle part \rangle}{\langle tikz code \rangle}
```

The origin of the TikZ figure is the lower left corner of the *\langle part \rangle*. Two rectangle nodes come into being: *part* and *trimmed part*. (Thank Zunbeltz Izaola for the idea.)

EXAMPLE

```
\begin{bookcover}
\bookcovercomponent{tikz}{bg whole}{
  \fill[yellow] (part.south west) rectangle (part.north east);
  \fill[gray] (trimmed part.south east) rectangle (trimmed part.north west);
  \draw[green] (0,0) circle [radius=10mm];}
\bookcovercomponent{tikz}{bg spine}{
  \fill[orange] (part.center) circle [radius=8mm];}
\end{bookcover}
```

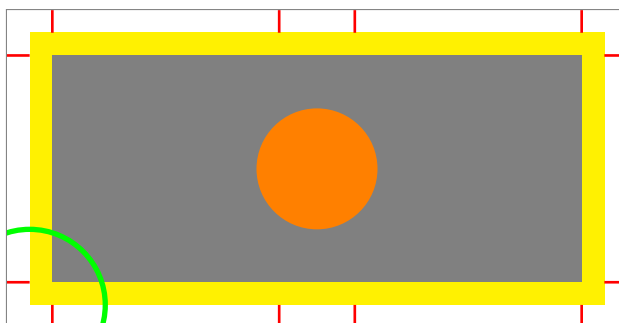
**3.3.4 Component type: tikz clip**

```
\bookcovercomponent{tikz clip}{\langle part \rangle}{\langle tikz code \rangle}
```

It works the same as the *tikz* component type, but it clips the *\langle part \rangle*.

EXAMPLE

```
\begin{bookcover}
\bookcovercomponent{tikz clip}{bg whole}{
  \fill[yellow] (part.south west) rectangle (part.north east);
  \fill[gray] (trimmed part.south east) rectangle (trimmed part.north west);
  \draw[green] (0,0) circle [radius=10mm];}
\bookcovercomponent{tikz clip}{bg spine}{
  \fill[orange] (part.center) circle [radius=8mm];}
\end{bookcover}
```

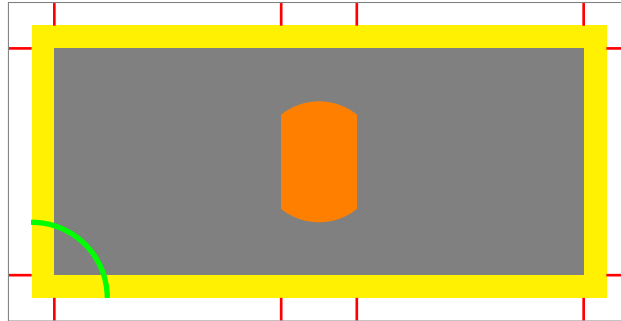

3.3.5 Component type: normal

`\bookcovercomponent{normal}{part}{content}`

In this case, the *content* is not specific. You can choose it as text or picture etc.

EXAMPLE

```
\begin{bookcover}
  \bookcovercomponent{normal}{front}{
    \vspace{5cm}
    \begin{center}
      {\bfseries\huge Book title}\\[5mm]
      \includegraphics[width=6cm]{fig.png}
    \end{center}
  }
\end{bookcover}
```

3.3.6 Component type: center

`\bookcovercomponent{center}{part}{content}`

It works the same as the normal component type, but the position of the content is the center of the part (horizontally and vertically).

EXAMPLE

```
\begin{bookcover}
  \bookcovercomponent{center}{above front}{
    \color{blue}Remark above front
  }
  \bookcovercomponent{center}{spine}{
    \rotatebox[origin=c]{90}{\bfseries\Large Book title}
  }
\end{bookcover}
```

3.3.7 Component type: ruler

Use the ruler component type to check the sizes of the part.

`\bookcovercomponent{ruler}{part}{\setruler [unit]{coordsys}{shift x}{shift y}{color}}`

unit The ruler unit:

- cm** Metric ruler (centimeter). Default value.
- in** English ruler (inch).

coordsys The type of the coordinate system:

- upper left** The origin is the upper left corner of the part.
- upper right** The origin is the upper right corner of the part.
- lower left** The origin is the lower left corner of the part.
- lower right** The origin is the lower right corner of the part.

shift x, *shift y* Moving the origin of the ruler to the vector $((shift\ x), (shift\ y))$.

color The color of the ruler.

EXAMPLE

```
\begin{bookcover}
\bookcovercomponent{ruler}{back}{\setruler{upper left}{0cm}{0cm}{blue}}
\bookcovercomponent{ruler}{back}{\setruler{upper left}{2cm}{1cm}{black}}
\bookcovercomponent{ruler}{front}{\setruler{lower right}{0cm}{0cm}{green}}
\bookcovercomponent{ruler}{front}{\setruler{lower right}{2cm}{1cm}{gray}}
\end{bookcover}
```

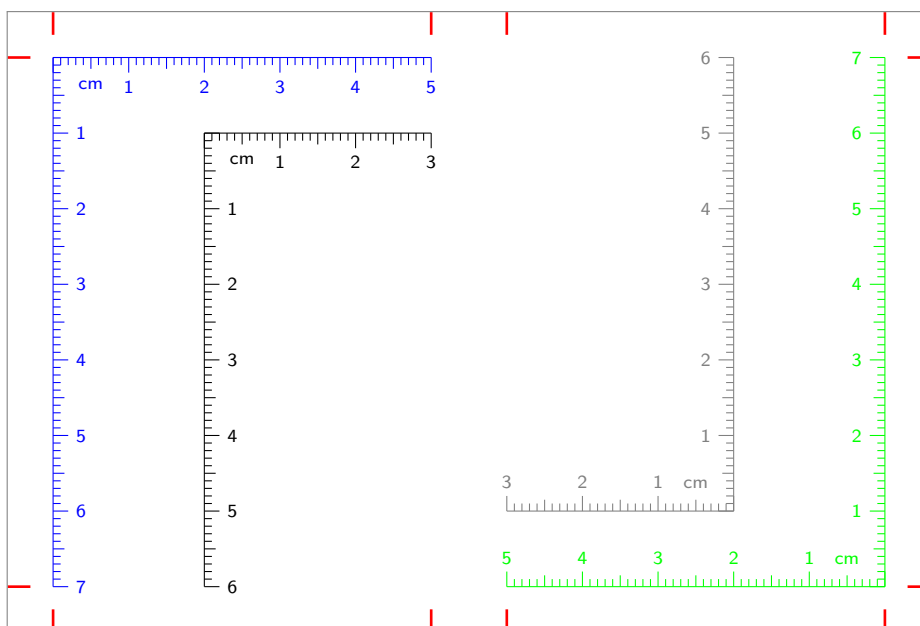

3.4 Defining component type

You can define a new component type, redefine or rename a defined component type with the following commands:

```
\newbookcovercomponenttype{<new component type name>}{<formatting>}
\renewbookcovercomponenttype{<defined component type name>}{<formatting>}
\newnamebookcovercomponenttype{<new component type name>}{<defined component type name>}
```

You can use the following length commands in *<formatting>*:

`\partwidth` Width of the part.
`\parheight` Height of the part.

You have to reference the content as #1.

EXAMPLE

```
\documentclass[spinewidth=1cm]{bookcover}
\newbookcovercomponenttype{center rotate}{
\parbox[t][\parheight][c]{\partwidth}{
\begin{center}
\rotatebox[origin=c]{90}{#1}
\end{center}}}
\begin{document}
\begin{bookcover}
\bookcovercomponent{center rotate}{spine}{Author -- Book title}
\end{bookcover}
\end{document}
```

3.5 Defining part

You can define a new part, redefine or rename a defined part with the following commands:

```
\newbookcoverpart{<new part name>}{<setting>}
\renewbookcoverpart{<defined part name>}{<setting>}
\newnamebookcoverpart{<new part name>}{<defined part name>}
```

In *<setting>* you have to set the new part sizes, the coordinates of its upper left corner (the origin is the upper left corner of the printed box), and the parameters of the `trimmed part` rectangle node in `tikz` and `tikz clip` component types. For this purpose, use the following commands:

```
\setpartposx{<coord x>}
\setpartposy{<coord y>}
\setpartwidth{<width>}
\setpartheight{<height>}
\settrimmedpart{<width minus>}{<height minus>}{<shift x>}{<shift y>}
```

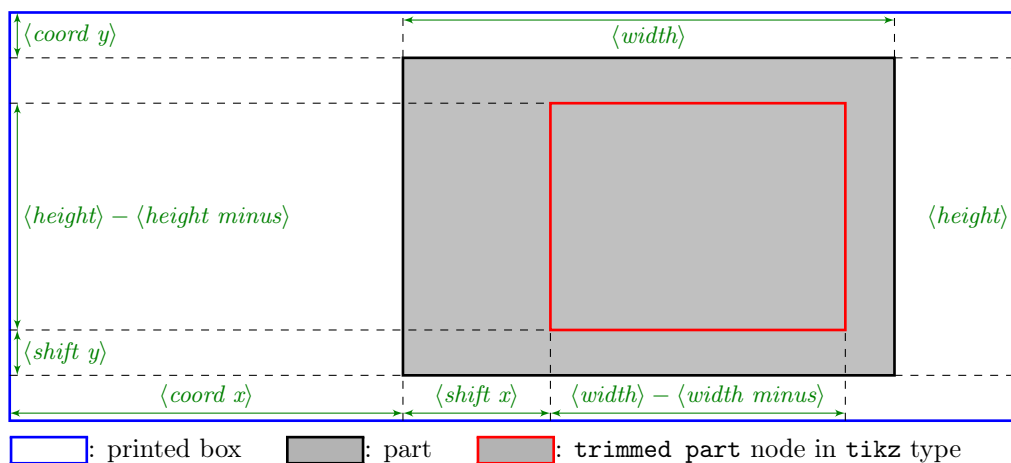

To give the previous lengths, you can use the following length commands:

```
\marklength \bleedwidth \flapwidth \coverwidth \spinewidth \coverheight
```

EXAMPLE

```
\documentclass[flapwidth=3cm]{bookcover}
\newbookcoverpart{bg half front}{
  \setpartposx{\marklength+\bleedwidth+\flapwidth+\spinewidth+1.5\coverwidth}
  \setpartposy{\marklength}
  \setpartheight{\coverheight+2\bleedwidth}
  \ifdim\flapwidth>0mm
    \setpartwidth{.5\coverwidth}
    \settrimmedpart{0pt}{2\bleedwidth}{0pt}{\bleedwidth}
  \else
    \setpartwidth{.5\coverwidth+\bleedwidth}
    \settrimmedpart{\bleedwidth}{2\bleedwidth}{0pt}{\bleedwidth}\fi}
\begin{document}
\begin{bookcover}
\bookcovercomponent{tikz}{bg half front}{
  \fill[blue] (part.south west) rectangle (part.north east);
  \fill[green] (trimmed part.south west) rectangle (trimmed part.north east);}
\end{bookcover}
\end{document}
```

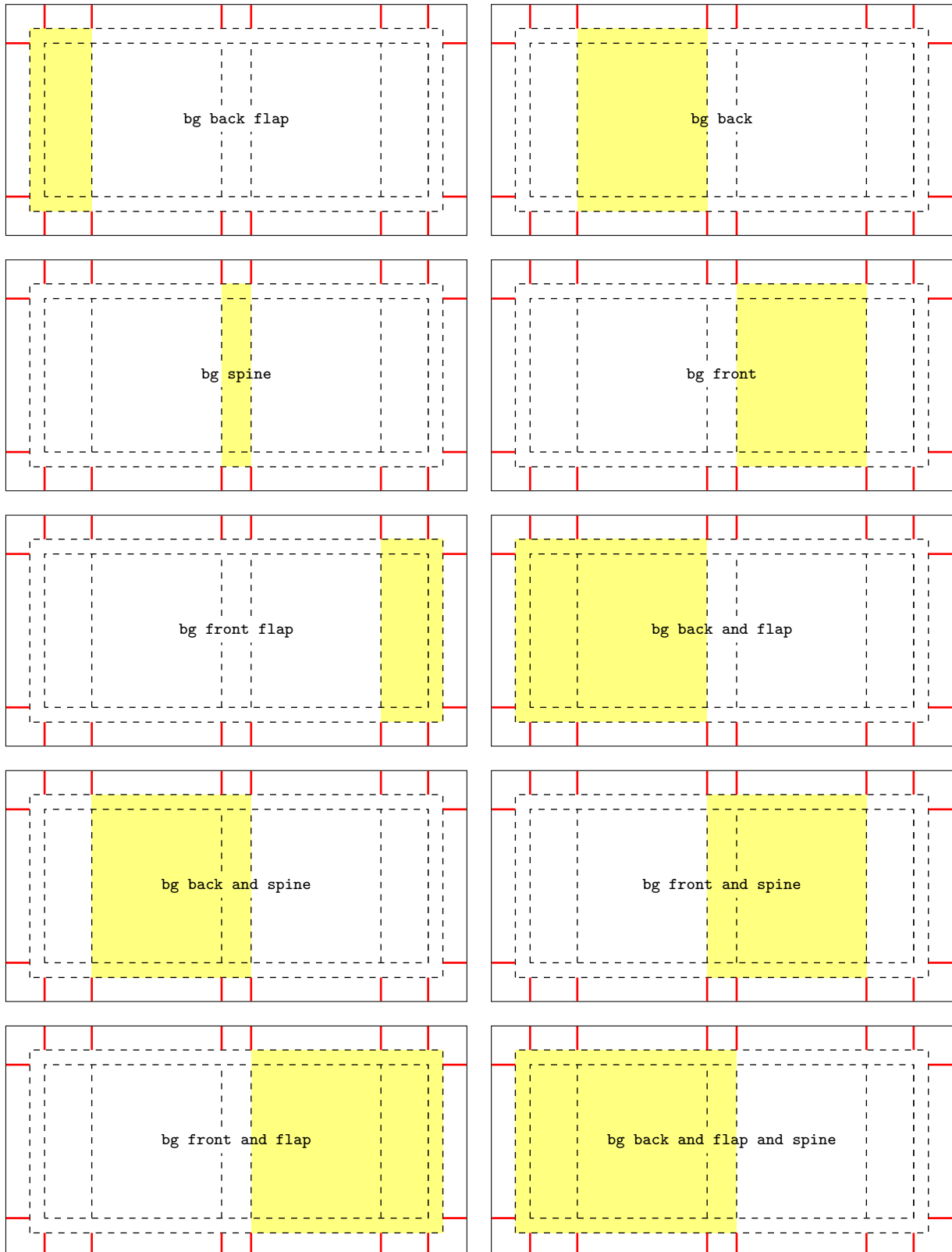

4 Illustration of the predefined parts

4.1 Background parts (cover width flaps)

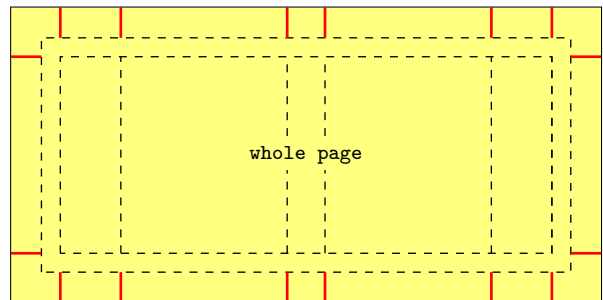
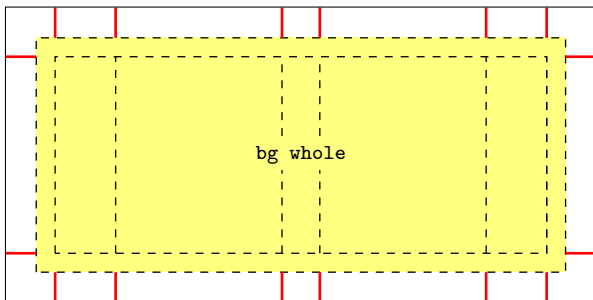
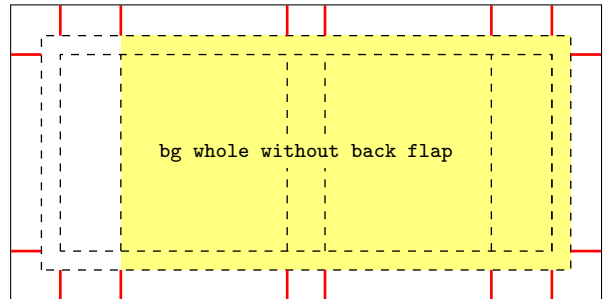
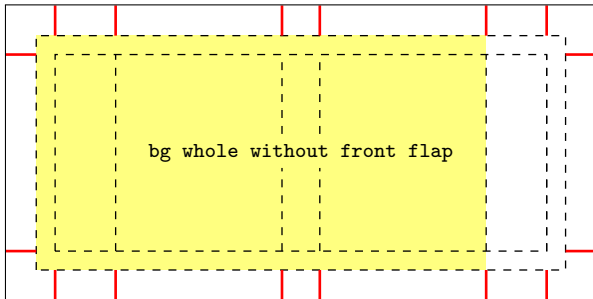
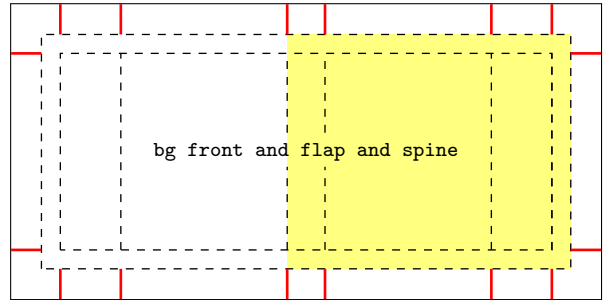
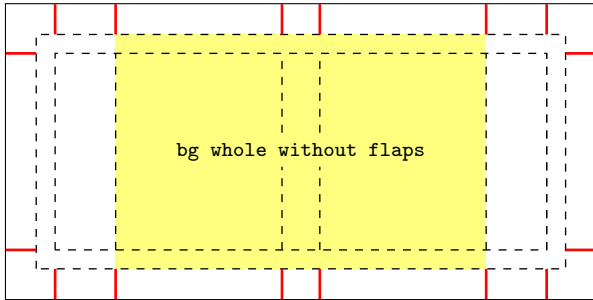

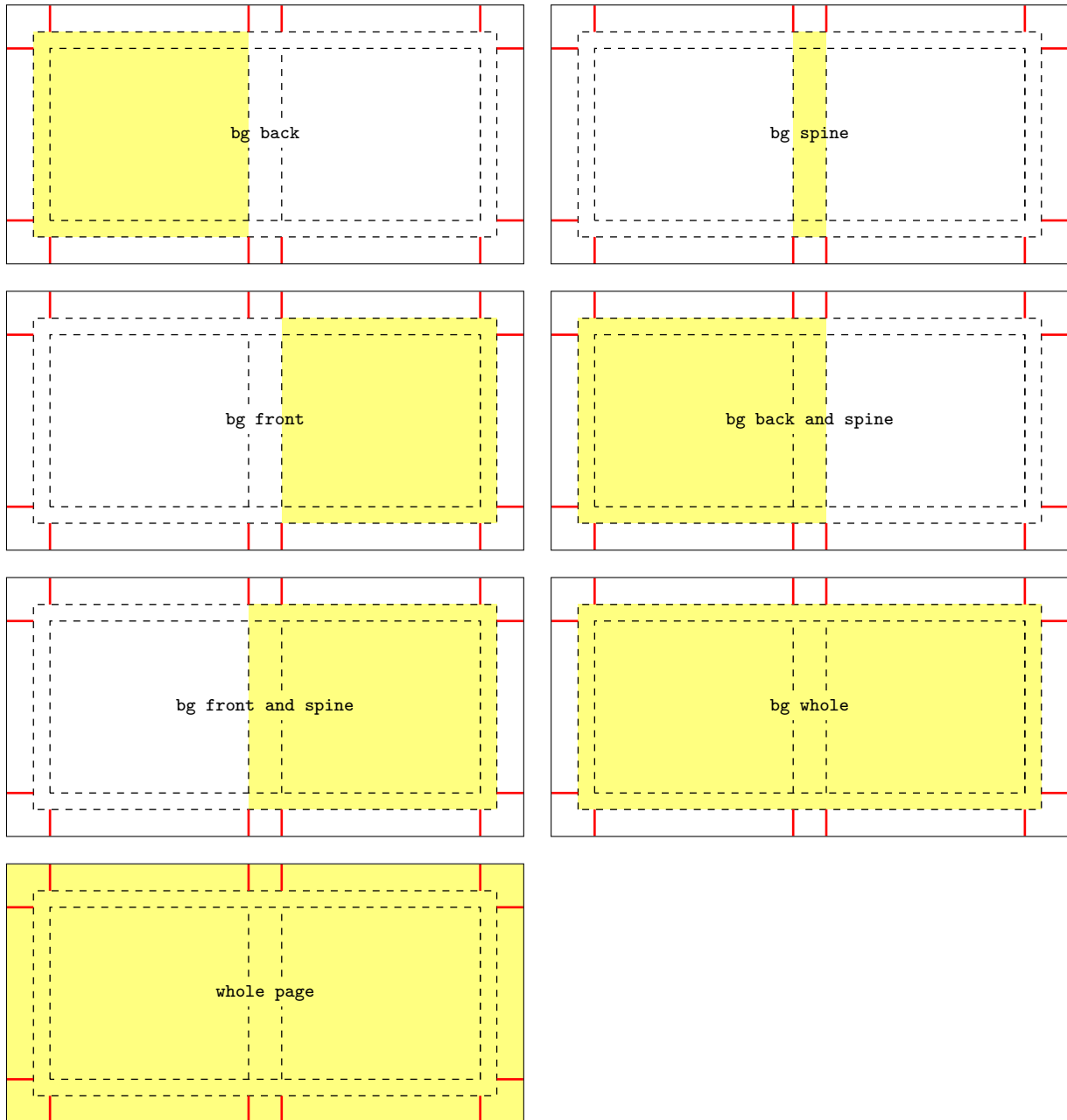

4.2 Background parts (cover without flaps)



4.3 Foreground parts (cover width flaps)

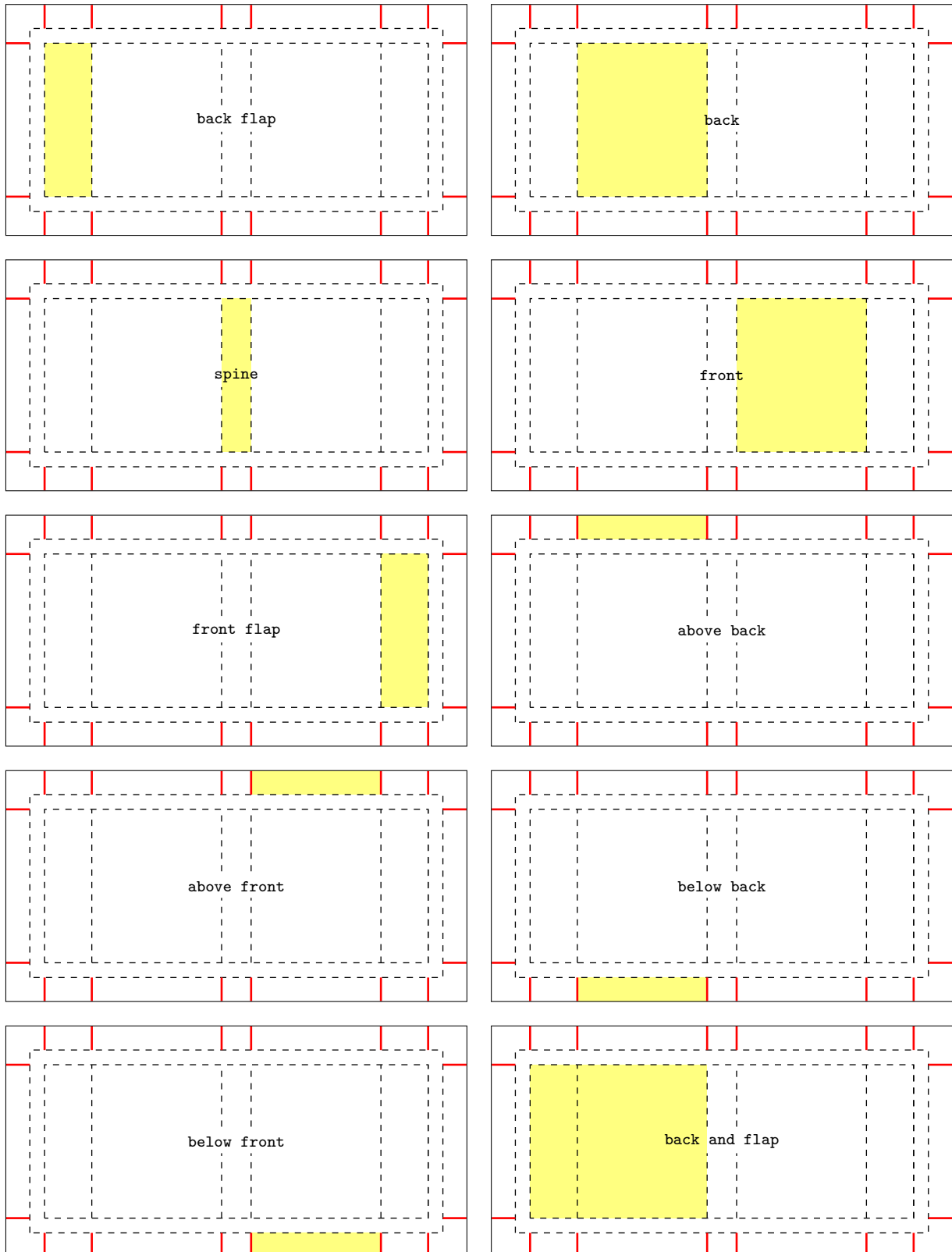

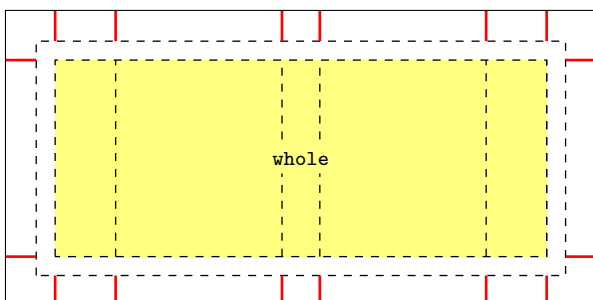
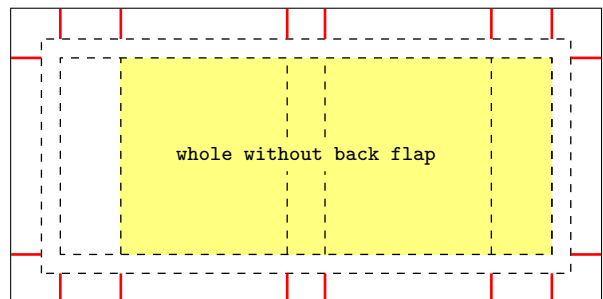
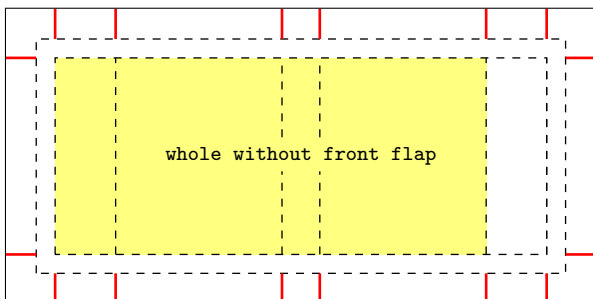
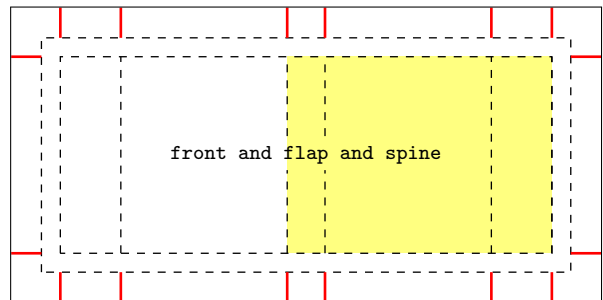
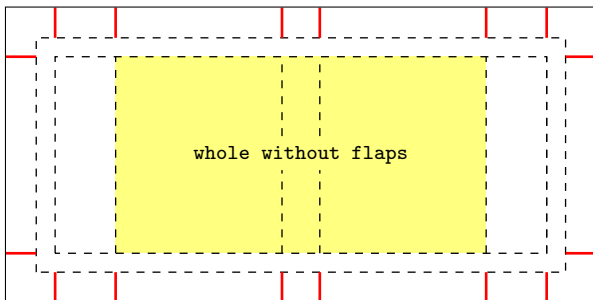
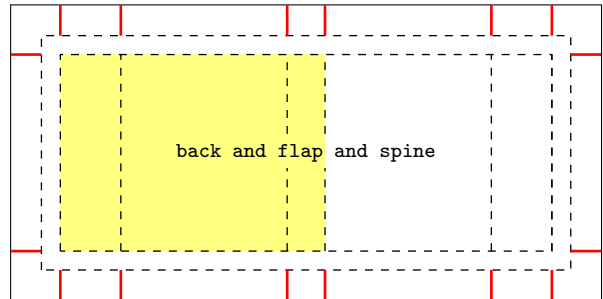
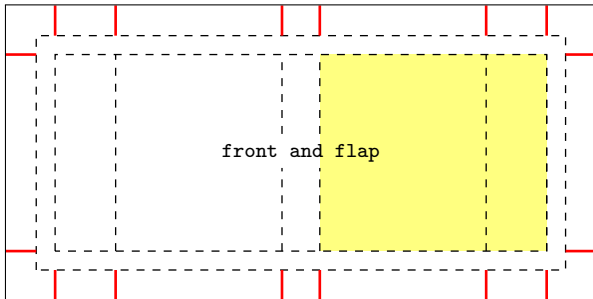
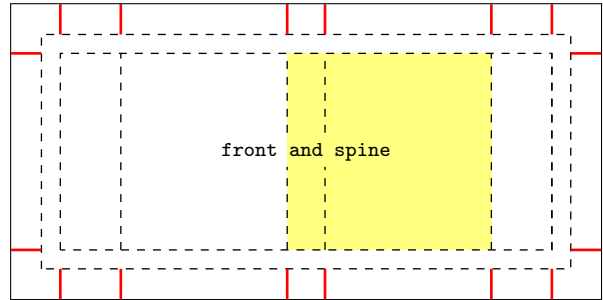
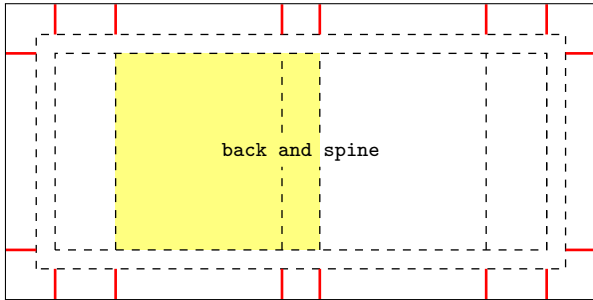

4.4 Foreground parts (cover without flaps)

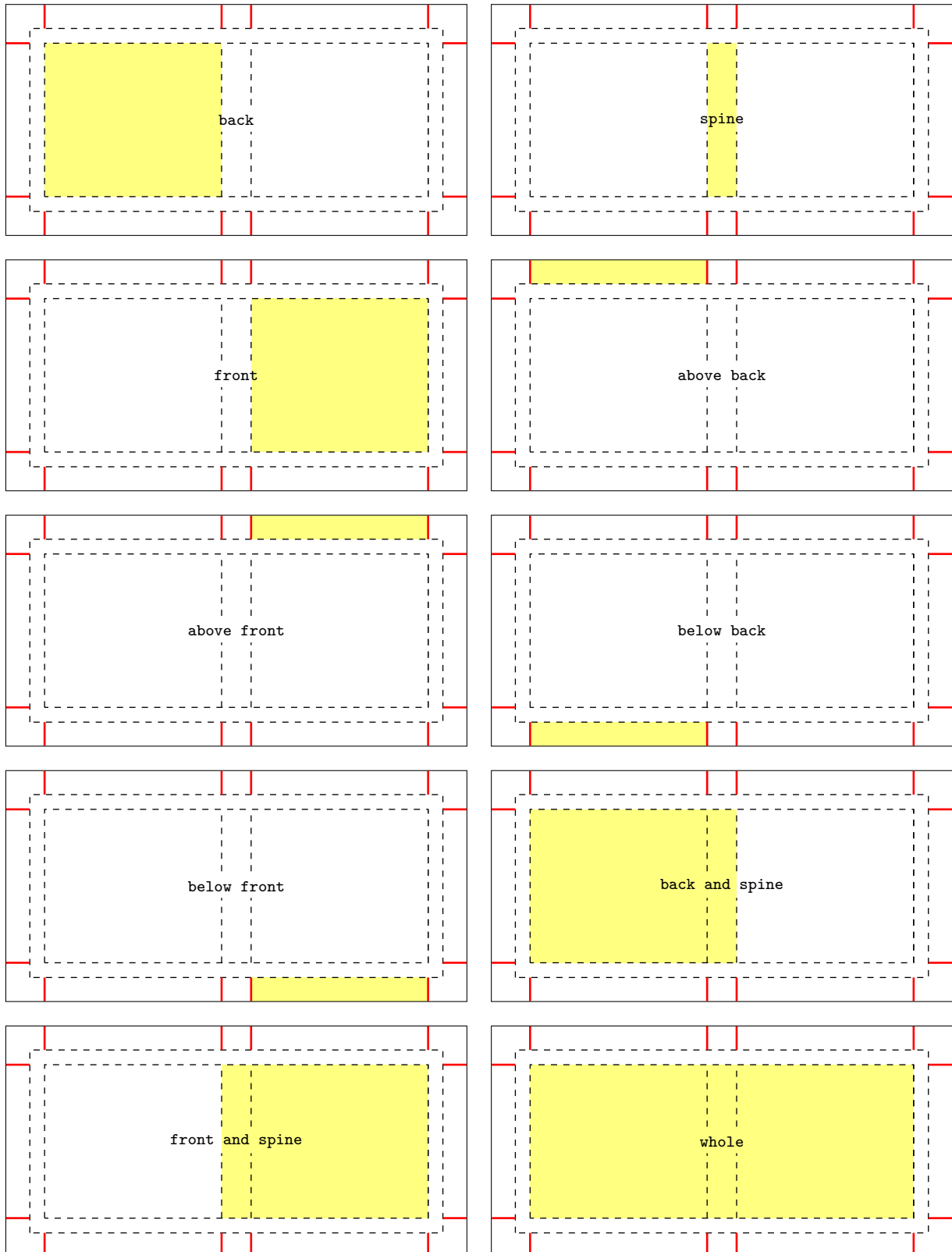

5 Full examples

5.1 A dust jacket

```
\documentclass[spinewidth=25mm,coverwidth=15cm,coverheight=20cm,flapwidth=6cm]{bookcover}
\newbookcovercomponenttype{center rotate}{
  \parbox[t][\parheight][c]{\partwidth}{
    \begin{center}
      \rotatebox[origin=c]{90}{#1}
    \end{center}}
}
\usepackage[outline]{contour}
\usepackage{lipsum}
\contourlength{1pt}
\definecolor{lightbrown}{RGB}{176,88,0}
\colorlet{title}{yellow!60!black}
\begin{document}

\begin{bookcover}

% Black background color on the whole cover
\bookcovercomponent{color}{bg whole}{color=black}

% Brown background picture on the whole cover, without the flaps
\bookcovercomponent{picture}{bg whole without flaps}{./figures/bg.jpg}

% Vertical light brown transparent trails on the back cover by a tikz code
\bookcovercomponent{tikz}{bg back}{
  \fill[opacity=0.3,color=lightbrown]
  (0mm,0mm) rectangle (20mm,210mm) (100mm,0mm) rectangle (150mm,210mm);}

% Vertical light brown transparent trails on the front cover by a tikz code
\bookcovercomponent{tikz}{bg front}{
  \fill[opacity=0.3,color=lightbrown]
  (0mm,0mm) rectangle (50mm,210mm) (130mm,0mm) rectangle (150mm,210mm);}

% Remark
\bookcovercomponent{center}{above front}{
  \color{blue}A DUST JACKET}

% Picture (cards.png) on the front, behind the title
\bookcovercomponent{normal}{front}{
  \vspace{70mm}
  \centering
  \includegraphics[width=8cm]{./figures/cards.png}}

% Text on the front cover
\bookcovercomponent{normal}{front}{
  \centering
  \vspace{60mm}
  \color{title}\sffamily\bfseries
  \resizebox*{50mm}{8mm}{\contour{black}{Rose Taylor}}
  \par\vspace{20mm}
  \resizebox*{90mm}{40mm}{\parbox{35mm}{
    \centering
    \contour{black}{PROBABILITY}\
    \contour{black}{THEORY}\}}

% Text on the spine
\bookcovercomponent{center rotate}{spine}{%
  \contour{black}{%
    \color{title}\huge\sffamily\bfseries%
    Rose Taylor -- Probability Theory}}
```

```

% Text on the back cover
\bookcovercomponent{normal}{back}{
  \centering
  \vspace{20mm}
  \parbox{110mm}{\color{white}\lipsum[1]}}

% Text and picture (dice.png) on the front flap
\bookcovercomponent{normal}{front flap}{
  \centering
  \vspace{20mm}
  \parbox{40mm}{\color{white}\lipsum[2]}
  \vfill
  \includegraphics[width=30mm]{./figures/dice.png}
  \vspace{10mm}}

% Text on the back flap
\bookcovercomponent{normal}{back flap}{
  \centering
  \vspace{20mm}
  \parbox{40mm}{\color{white}\lipsum[2]}}

\end{bookcover}

\end{document}

```

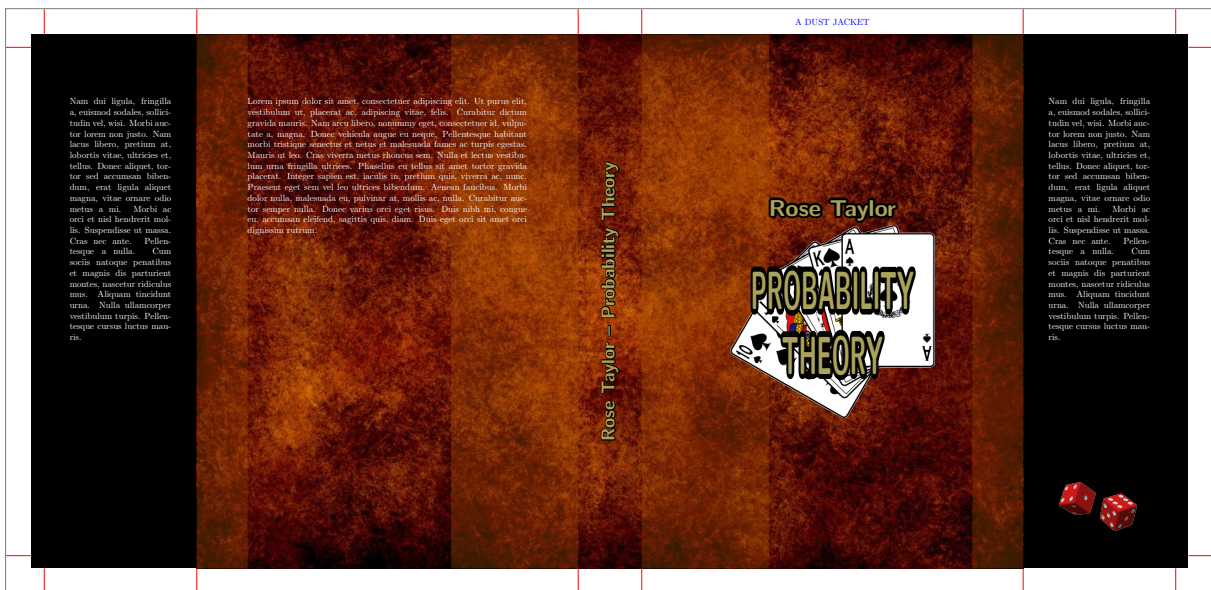

5.2 A two-sided book cover

```

\documentclass[markcolor=black,spinewidth=15mm]{bookcover}
\usepackage[utf8]{inputenc}
\usepackage[T1]{fontenc}
\usepackage[english]{babel}
\usepackage{url,lipsum}
\definecolor{amiyellow}{cmyk}{0,0,.5,0}
\begin{document}

% The outside of the book cover
\begin{bookcover}

% Yellow triangle on the back cover by tikz code
\bookcovercomponent{tikz}{bg back}{
  \fill[color=amiyellow](.5,.5)--(17.5,24.5)--(17.5,0)--(.5,0)--cycle;}

```



```

% Yellow triangle on the front cover by tikz code
\bookcovercomponent{tikz}{bg front}{
  \fill[color=amiyellow](0,0)--(0,24.5)--(17,.5)--(17,0)--cycle;}

% Yellow background color on the spine
\bookcovercomponent{color}{bg spine}{color=amiyellow}

% Remark
\bookcovercomponent{center}{above front}{
  \color{red}\textsc{Annales Mathematicae et Informaticae} book cover -- outside}

% Text on the spine
\bookcovercomponent{center}{spine}{
  \rotatebox[origin=c]{90}{\footnotesize\bfseries
    ANNALES MATHEMATICAE ET INFORMATICAЕ 43.\ (2014)}}

% Text and pictures (summa.pdf, ekflogo.pdf) on the front cover
\bookcovercomponent{normal}{front}{
  \vspace{30.5mm}
  \centering
  {\huge\bfseries ANNALES\ \ MATHEMATICAE ET\ \ INFORMATICAЕ\ \ [13mm]}
  {\large\bfseries TOMUS 43.\ (2014)}\ \ [10mm]
  \includegraphics{./figures/summa.pdf}
  \vfill
  {\large COMMISSIO REDACTORIUM}\ \ [3mm]
  \parbox{123mm}{\centering\lipsum[2]\par}
  \vfill
  {\large\bfseries HUNGARIA}
  \vspace{10mm}}

\end{bookcover}

% The inside of the book cover
\begin{bookcover}

% Remark
\bookcovercomponent{center}{above front}{
  \color{red}\textsc{Annales Mathematicae et Informaticae} book cover -- inside}

% Text on the front cover (it is back of the inside book cover!)
\bookcovercomponent{normal}{front}{
  \vspace{27mm}
  \begin{center}
    \bfseries
    ANNALES MATHEMATICAE ET INFORMATICAЕ\ \ [3mm]
    International journal for mathematics and computer science\ \ [3mm]
    Referred by\ \
    Zentralblatt für Mathematik\ \
    and\ \
    Mathematical Reviews\ \
  \end{center}
  \bigskip
  \begin{center}
    \parbox{126mm}{\lipsum[1]}
  \end{center}}

\end{bookcover}

\end{document}

```

ANNALES MATHEMATICAE ET INFORMATICAЕ

TOMUS 43. (2014)

ANNALES MATHEMATICAE ET INFORMATICAЕ 43. (2014)



COMMISSIO REDACTORUM

Nam dui ligula, fringilla a, euismod sodales, sollicitudin vel, wisi. Morbi auctor lorem non justo. Nam lacus libero, pretium at, lobortis vitae, ultricies et, tellus. Donec aliquet, tortor sed accumsan bibendum, erat ligula aliquet magna, vitae ornare odio metus a mi. Morbi ac orci et nisl hendrerit mollis. Suspendisse ut massa. Cras nec ante. Pellentesque a nulla. Cum sociis natoque penatibus et magnis dis parturient montes, nascetur ridiculus mus. Aliquam tincidunt urna. Nulla ullamcorper vestibulum turpis. Pellentesque cursus luctus mauris.

HUNGARIA

ANNALES MATHEMATICAE ET INFORMATICAЕ
International journal for mathematics and computer science

Referred by
Zentralblatt für Mathematik
and
Mathematical Reviews

Lorem ipsum dolor sit amet, consectetur adipiscing elit. Ut purus elit, vestibulum ut, placerat ac, adipiscing vitae, felis. Curabitur dictum gravida mauris. Nam arcu libero, nonummy eget, consectetur id, vulputate a, magna. Donec vehicula augue eu neque. Pellentesque habitant morbi tristique senectus et netus et malesuada fames ac turpis egestas. Mauris ut leo. Cras viverra metus rhoncus sem. Nulla et lectus vestibulum urna fringilla ultrices. Phasellus eu tellus sit amet tortor gravida placerat. Integer sapien est, iaculis in, pretium quis, viverra ac, nunc. Praesent eget sem vel leo ultrices bibendum. Aenean faucibus. Morbi dolor nulla, malesuada eu, pulvinar at, mollis ac, nulla. Curabitur auctor semper nulla. Donec varius orci eget risus. Duis nibh mi, congue eu, accumsan eleifend, sagittis quis, diam. Duis eget orci sit amet orci dignissim rutrum.

5.3 Barcode

```
\documentclass{bookcover}
\usepackage{pst-barcode}
\begin{document}
\begin{bookcover}
  \bookcovercomponent{normal}{back}{
    \vfill
    \centering
    \begin{pspicture}(1.5in,1in)
      \psbarcode{1787-6117}{includetext height=1 width=1.5}{issn}
    \end{pspicture}
    \vspace{5mm}}
\end{bookcover}
\end{document}
```

You can compile this file with `latex.exe` or `xelatex.exe`. Using `pdflatex.exe` or `lualatex.exe`, write the following code into the preamble:

```
\usepackage[pdfcrop={-hires}]{auto-pst-pdf}
```

In this case, the command to compile this file is the following:

```
pdflatex -shell-escape filename
or
lualatex -shell-escape filename
```



6 Obsolete method

The goal of the *obsolete method* is to be compatible with the early versions of the bookcover. It is not recommended to use it in the future, because the method described in the Section 3 is much more flexible!

6.1 Commands

Background colors

```
\setbookcover{bgcolor}{<background part>}{<colors>}
```

See the *<background part>* in Subsubsection 6.2.1 and the *<colors>* in the page 4.

Background pictures

```
\setbookcover{bgpic}{<background part>}{<picture file>}
```

See the *<background part>* in Subsubsection 6.2.1. The picture will be rescaled according to the sizes of the current background part.

Background TikZ figures

```
\setbookcover{bgtikz}{<background part>}{<tikz code>}
```

See the *<background part>* in Subsubsection 6.2.1. The TikZ figure will be placed to the upper left corner of the current background part, without resizing. Using the option `bgtikznodes` of the document class:

- the origin moves to the lower left corner of the current background part;
- two rectangle nodes come into being: `part` and `trimmed part`.

The option `bgtikzclip` of the document class works the same as `bgtikznodes`, but it clips the current part.

First foreground

```
\setbookcover{fgfirst}{<foreground part>}{<content>}
```

See the *<foreground part>* in Subsubsection 6.2.2. The first foreground is the top layer of the book cover (see Subsection 6.3).

Second foreground

```
\setbookcover{fgsecond}{<foreground part>}{<content>}
```

See the *<foreground part>* in Subsubsection 6.2.2. The second foreground is under the first foreground (see Subsection 6.3).

Making book cover

```
\makebookcover
```

This command makes the book cover by using the contents of the background and foreground.

6.2 Parts in the obsolete method

6.2.1 Background parts

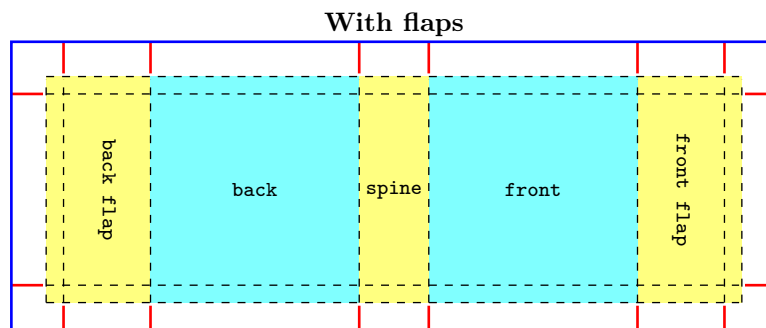

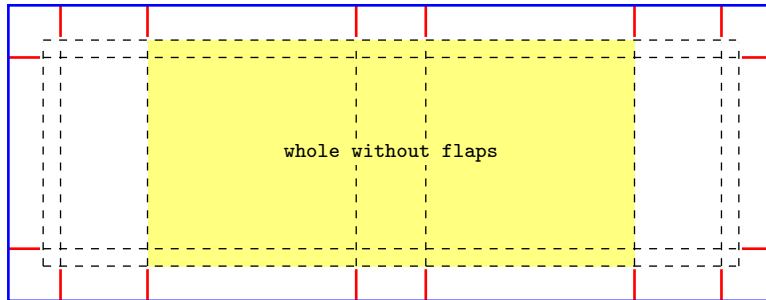
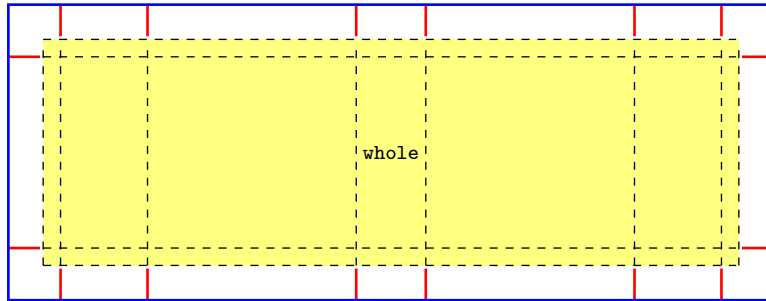

Without flaps

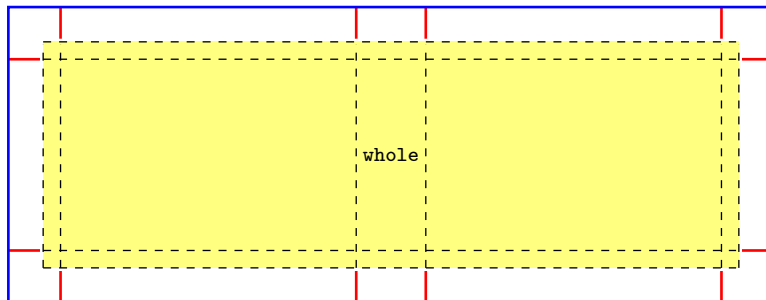
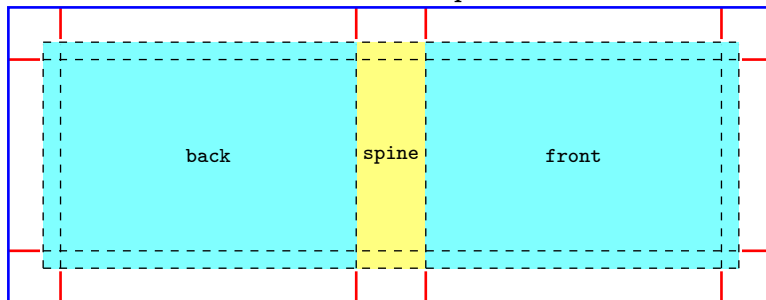

6.2.2 Foreground parts

With flaps

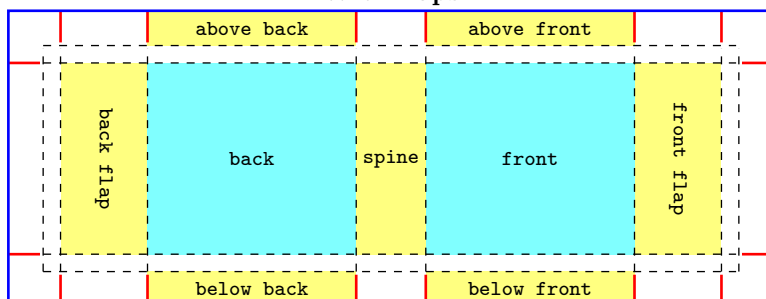

Without flaps

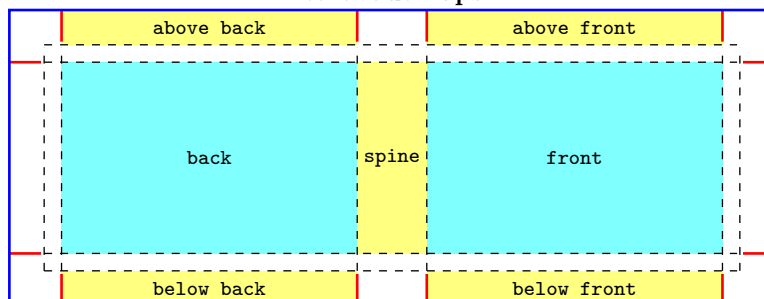

The other name of above front is remark.

6.3 Layers

In the following table we can see the hierarchy of the layers:

fgfirst	above front, below front, above back, below back back, front, spine, front flap, back flap	top layer ↑
fgsecond	back, front, spine, front flap, back flap	↑
bgtikz	back, front, spine, front flap, back flap whole without flaps whole	↑ ↑ ↑
bgpic	back, front, spine, front flap, back flap whole without flaps whole	↑ ↑ ↑
bgcolor	back, front, spine, front flap, back flap whole without flaps whole	↑ ↑ bottom layer

6.4 Example

See the figure in the page 16.

```
\documentclass[spinewidth=25mm,coverwidth=15cm,coverheight=20cm,flapwidth=6cm]{bookcover}
\usepackage[outline]{contour}
\usepackage{lipsum}
\contourlength{1pt}
\definecolor{lightbrown}{RGB}{176,88,0}
\colorlet{title}{yellow!60!black}

\begin{document}

% Black background color on the whole cover
\setbookcover{bgcolor}{whole}{color=black}

% Brown background picture on the whole cover, without the flaps
\setbookcover{bgpic}{whole without flaps}{./figures/bg.jpg}

% Vertical light brown transparent trails on the back cover by a tikz code
\setbookcover{bgtikz}{back}{
  \fill[opacity=0.3,color=lightbrown]
  (0mm,0mm) rectangle (20mm,210mm) (100mm,0mm) rectangle (150mm,210mm);}

% Vertical light brown transparent trails on the front cover by a tikz code
\setbookcover{bgtikz}{front}{
  \fill[opacity=0.3,color=lightbrown]
  (0mm,0mm) rectangle (50mm,210mm) (130mm,0mm) rectangle (150mm,210mm);}

% Remark
\setbookcover{fgfirst}{above front}{
```

```

\color{blue}A DUST JACKET}

% Text on the front cover
\setbookcover{fgfirst}{front}{
  \centering
  \vspace{60mm}
  \color{title}\sffamily\bfseries
  \resizebox*{50mm}{8mm}{\contour{black}{Rose Taylor}}
  \par
  \vspace{20mm}
  \resizebox*{90mm}{40mm}{\parbox{35mm}{
    \centering
    \contour{black}{PROBABILITY}\
    \contour{black}{THEORY}\}}}

% Picture (cards.png) on the front, behind the title
\setbookcover{fgsecond}{front}{
  \vspace{70mm}
  \centering
  \includegraphics[width=8cm]{./figures/cards.png}}

% Text on the spine
\setbookcover{fgfirst}{spine}{%
  \vfill
  \centering
  \rotatebox[origin=c]{90}{\contour{black}{%
    \color{title}\huge\sffamily\bfseries%
    Rose Taylor -- Probability Theory}}
  \vfill}

% Text on the back cover
\setbookcover{fgfirst}{back}{
  \centering
  \vspace{20mm}
  \parbox{110mm}{\color{white}\lipsum[1]}}

% Text and picture (dice.png) on the front flap
\setbookcover{fgfirst}{front flap}{
  \centering
  \vspace{20mm}
  \parbox{40mm}{\color{white}\lipsum[2]}
  \vfill
  \includegraphics[width=30mm]{./figures/dice.png}
  \vspace{10mm}}

% Text on the back flap
\setbookcover{fgfirst}{back flap}{
  \centering
  \vspace{20mm}
  \parbox{40mm}{\color{white}\lipsum[2]}}

% Making the dust jacket
\makebookcover

\end{document}

```